

Sign Program No. 31
Summary of APPROVED SIGNS FOR EMANATE HEALTH
210 W San Bernardino Road
Revised 4-29-2020

Sign type numbers	Sign Height (ft)	Sign Dimensions (ft)	Sign Area (sq ft)	General Location (see map and/or elevations)
Wall Sign				
105 and 105A		4 X 28	112	main building entry face W San Bernardino Rd
Monument Signs				
001	5	5 X 11.5	57.5	SWC W San Bernardino Rd & N Third Ave
002	6	11.5	55 (sign face only) total area is 69	main entry off W San Bernardino Rd; must set back 3 feet from Property Line
008	6	11.5	69	
028	5.6	5.6 X 2.7	15	1 st driveway entry off N Fourth Ave
041	6	6 X 6	36	2 nd driveway entry off N Fourth Ave
052a	6	6 X 6	36	at N Fourth – within landscape area
052b	6	6 X 6	36	at W College – within landscape area
192	4	4 X 9.2	37	main entry off N Third Ave
Directory Signs				
004a and 004b	8 inches	37 inches		
009	5	5 X 2.7	13.3	on-site
011	5	5 X 2.7	13.3	on-site
070	5	5 X 10.6		NWC W College & N Third ER driveway entrance
080	5	5 X 9.2		N Third ER driveway entrance
081	3	3 X 4		NEC W College & N Third; must set back behind Property Line
082 and 082a	5	2.6 X 4		N Third Ave parking lot
094 and 094a	5	2.6 X 4		N Third Ave parking lot
095 and 095a	5	2.6 X 4		N Third Ave parking lot
097 and 097a	6.9	2.7 X 6.3		W Cottage and N Third
103	5	5 X 2.7		on-site by building
106	5	5 X 2.7		on-site by building
150 (REMOVED)	5	1.75 X 4		on-site parking area
152	4	4 X 2		on-site parking area
156, 164, 184	5	5 X 2.7		on-site parking area

By: _____
 Any changes or alterations to the approved plans will require review and approval from the Planning Division.

By: _____
 Any changes or alterations to the approved plans will require review and approval from the Planning Division.

APR 29 2020

CITY OF COVINA
 PLANNING DIVISION
 CITY PLANNER APPROVED
 Case File _____

Any changes or alterations to the approved plans will require review and approval from the Planning Division

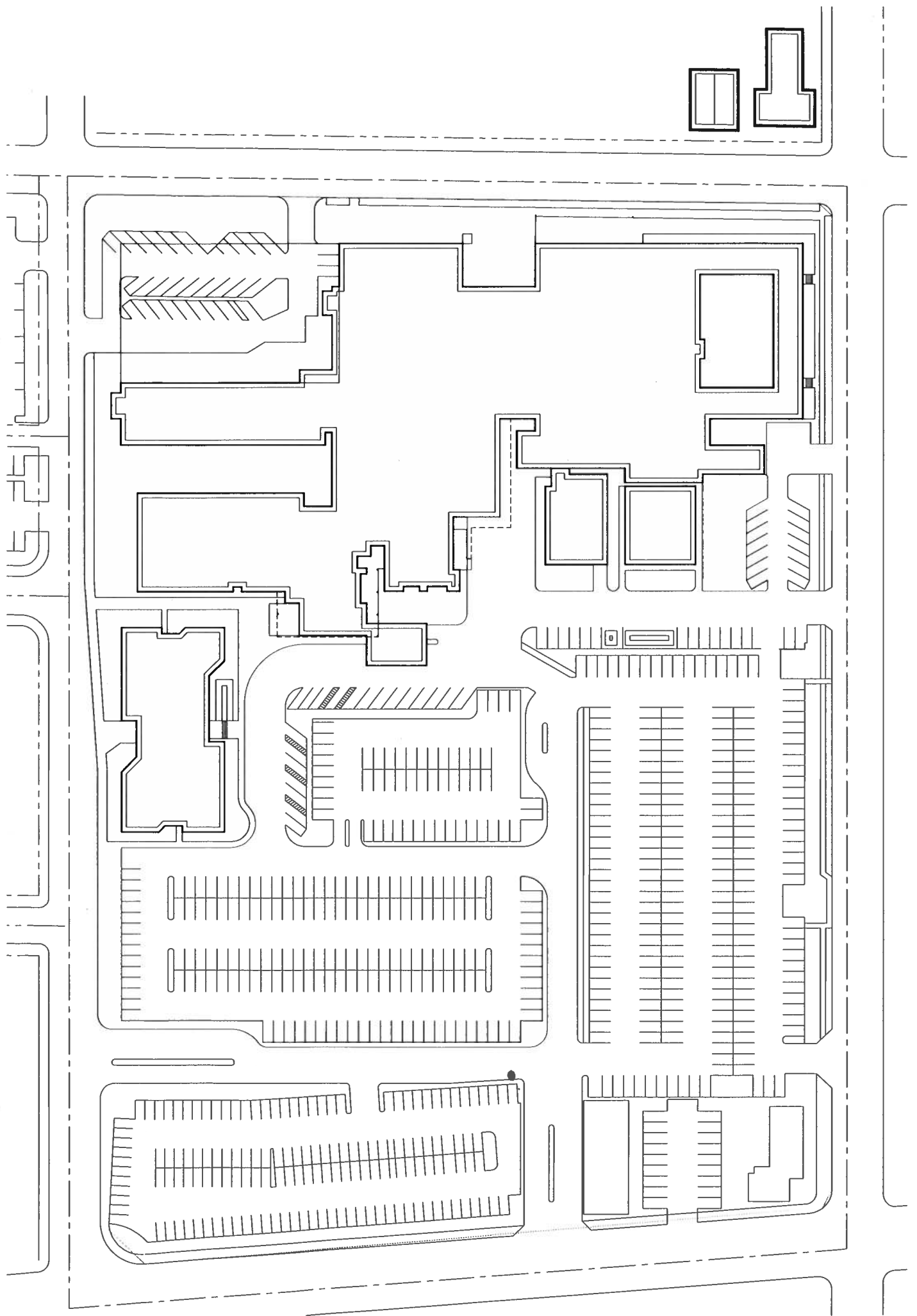

SignCHART

Emanate Health



Site Number:

CVHP001

Site Name:

Inter-Community Hospital
210 W. San Bernardino Road
Covina, CA 91723 United States

Recommendation Completed: 11-25-2019

Approved: 12-03-2019

Date Print: 01/09/2020

Leased/Owned:



ICON

Proj #:	Revision #:	Req. #:	Date:	Artist:	Revision #:	Req. #:	Date:	Artist:
5070	Original	322102	01/17/20	XXX	Rev 6	000000	00/00/00	XXX
	Rev 1	000000	00/00/00	XXX	Rev 7	000000	00/00/00	XXX
	Rev 2	000000	00/00/00	XXX	Rev 8	000000	00/00/00	XXX
	Rev 3	000000	00/00/00	XXX	Rev 9	000000	00/00/00	XXX
	Rev 4	000000	00/00/00	XXX	Rev 10	000000	00/00/00	XXX
	Rev 5	000000	00/00/00	XXX	Rev 11	000000	00/00/00	XXX
1133484								

File Path: Active\ACCCOUNTS\Emanate Health\Project 5070\Locations\5070_0001_Covina_CA

CITY OF COVINA
 PLANNING DIVISION
 CITY PLANNER APPROVED
 Case File SIGN ROADWAY
 MAR 16 2020
 By: [Signature]
 Any changes or alterations to the approved plans will require review and approval from the Planning Division

NO 31

Site Number: CVHP001

CVHP001_Inter-CommunityHospital Print Book

Site Name: Inter-CommunityHospital

Address: 210 W. San Bernardino Road

City/State: Covina, CA 91723

Recommendation Completed: 11-25-2019

Approved: 12-03-2019

Date Print: 01/09/2020

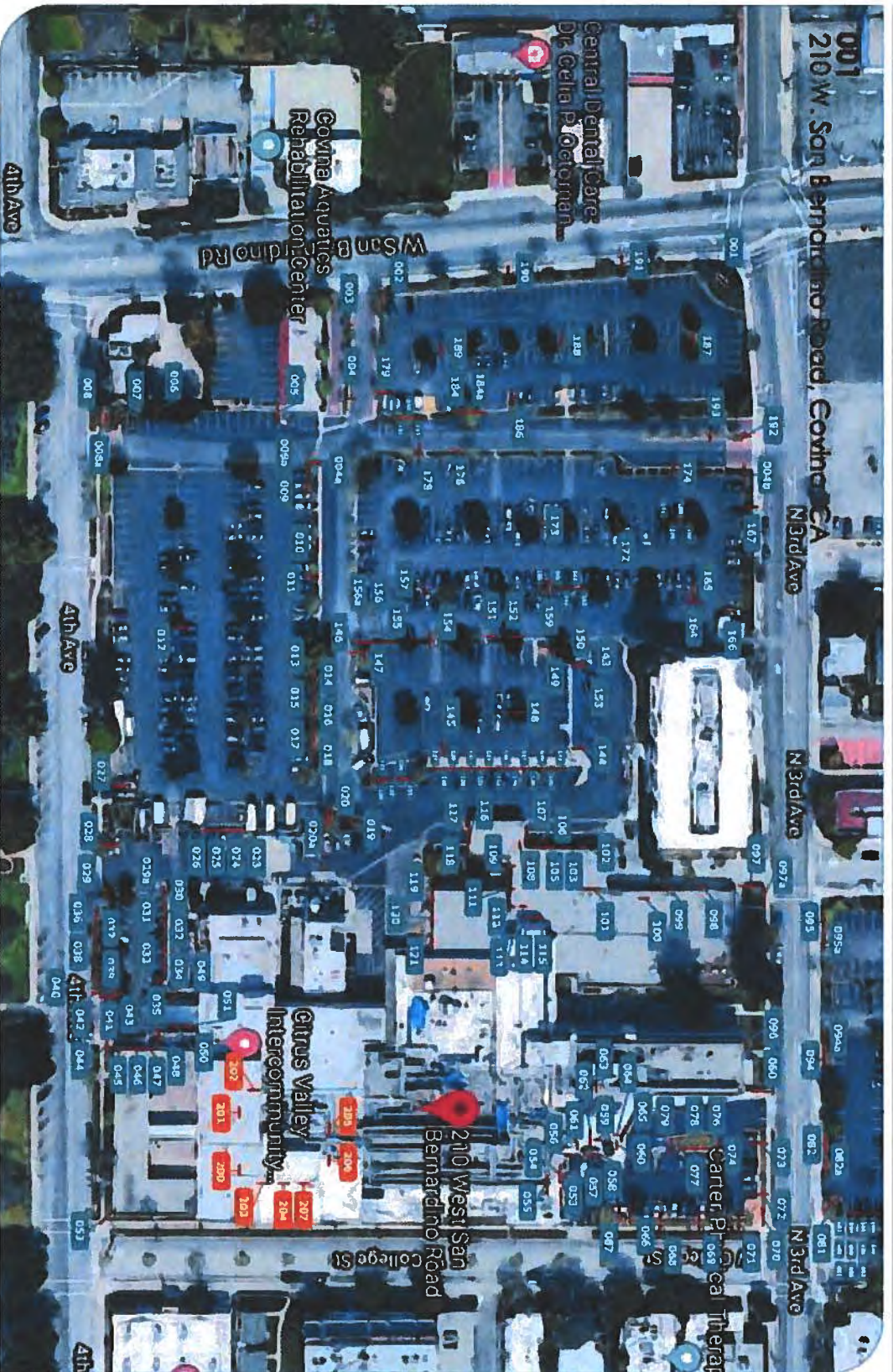

Existing Photo



Proposed Photo



Existing

Asset Zone: Sign

Sign Number: 001

Existing Sign Type: Monument

Face Material: Acrylic

Graphics Material: Acrylic

Overall Height: 72.5"

Face Height: 63"

Face Width: 194"

Square Feet: Externally Illuminated

Illuminated: Externally Illuminated

Electrical:

Wall Material:

Sign Comment:

Recommendation

Description	Sq. Ft.	Qty
Custom D.F. Illuminated Monument	57.3	1

NOTES:
 Custom monument sign in the style of a M-5. Emanate logo to be full color push through letters. Locator name to be flushed in. Both illuminate at night.

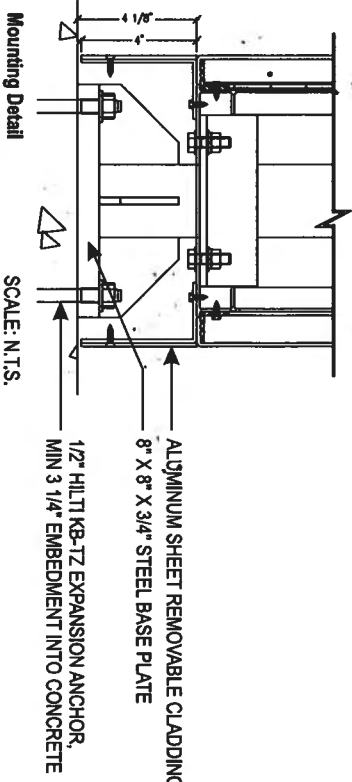
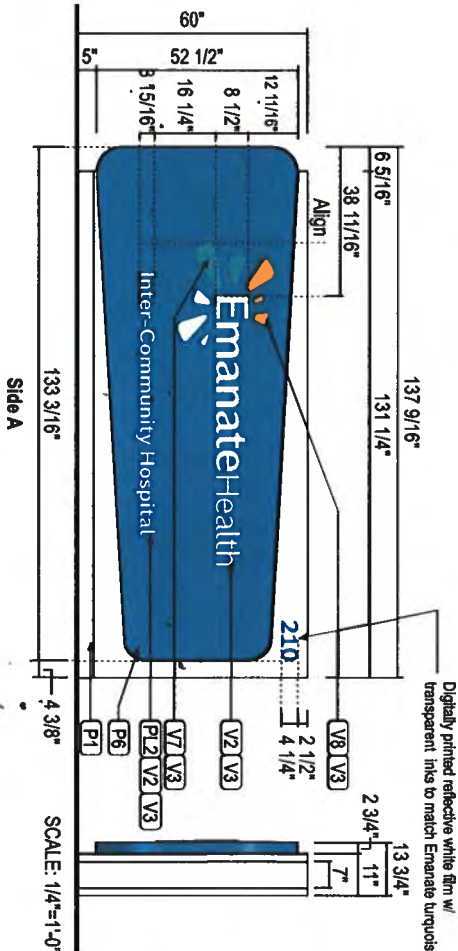

Existing Photo



Proposed Photo

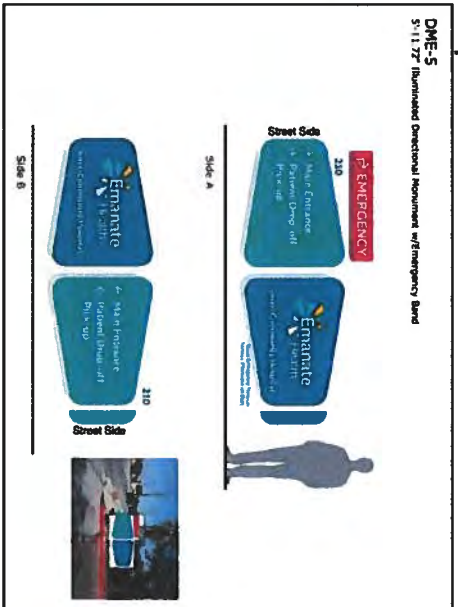

Existing

Asset Zone: Sign
 Sign Number: 002
 Existing Sign Type: Monument
 Face Material: Flat Plastic
 Graphics Material: Vinyl
 Overall Height: 85"
 Face Height: 60"
 Face Width: 74.5"
 Square Feet: Internally Illuminated
 Electrical:
 Wall Material:
 Sign Comment: 10.5" thick
 Recommendation

*MUST SET BACK
 3 FT FROM
 PROPERTY LINE*

Description	Sq. Ft.	Qty.
DME-5 D.F. Illuminated Directional Monument	66.7	1

NOTES:

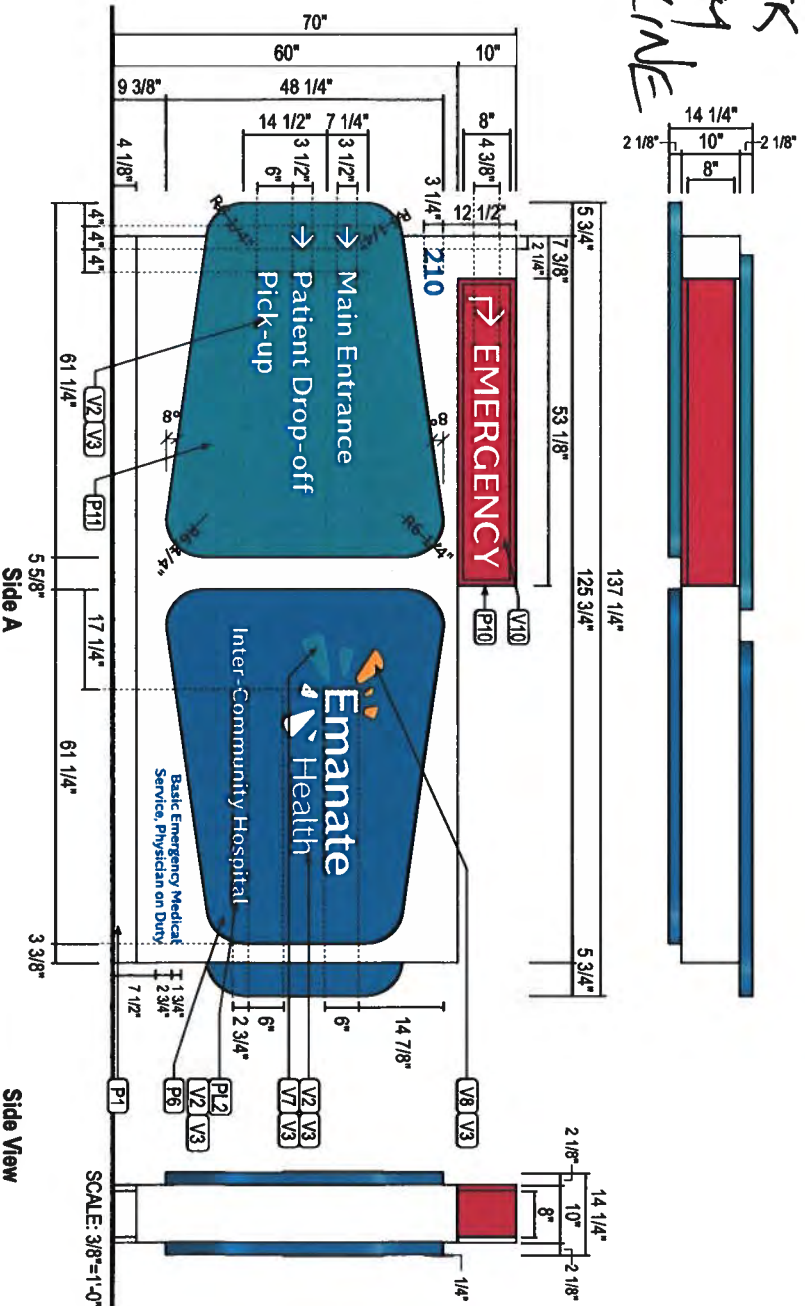

Existing Photo



Proposed Photo



Existing

Asset Zone: Sign

Sign Number: 004b

Existing Sign Type:

Face Material:

Graphics Material:

Overall Height:

Face Height:

Face Width:

Square Feet:

Illuminated: Non Illuminated

Electrical:

Wall Material:

Sign Comment:

Recommendation

Description	Sq. Ft.	Qty
D-TE-3-NIL		
D.F. Non-Illum. Trailblazer Emergency Sign	N/A	1

NOTES:
Sign to be placed on corner.
Wayfinding from sign 004a directs to this one.

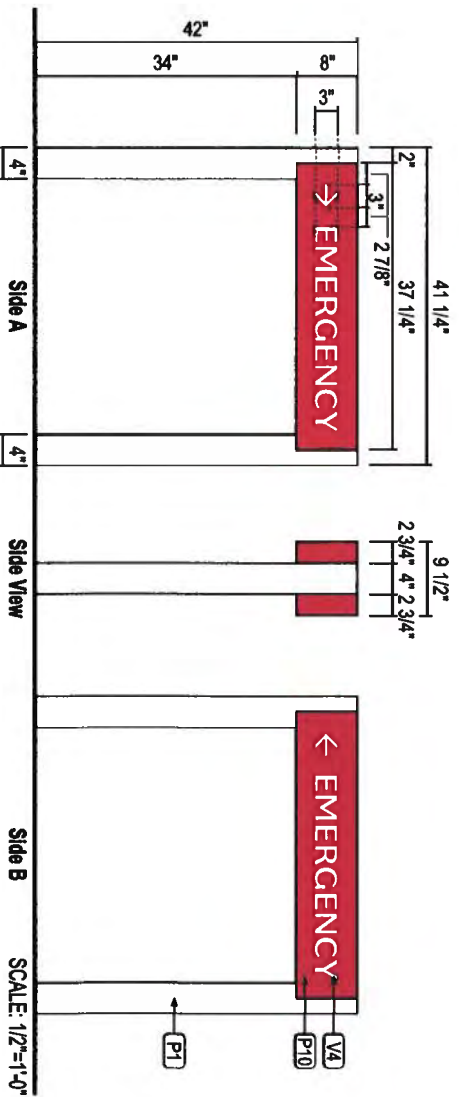

Existing Photo



Existing

Asset Zone:	Sign
Sign Number:	011
Existing Sign Type:	Monument
Face Material:	Flat Plastic
Graphics Material:	Vinyl
Overall Height:	52"
Face Height:	36"
Square Feet:	Non Illuminated
Illuminated:	
Electrical:	
Wall Material:	
Sign Comment:	4.5" thick

Recommendation

Description	Sq. Ft.	Qty.
D-NB-5-NIL D-F, Non-Illuminated Directional	13	1

NOTES:
 Sign should be moved slightly south to align more to visitor entrance.
 Restore ground material to base of new sign.

Proposed Photo

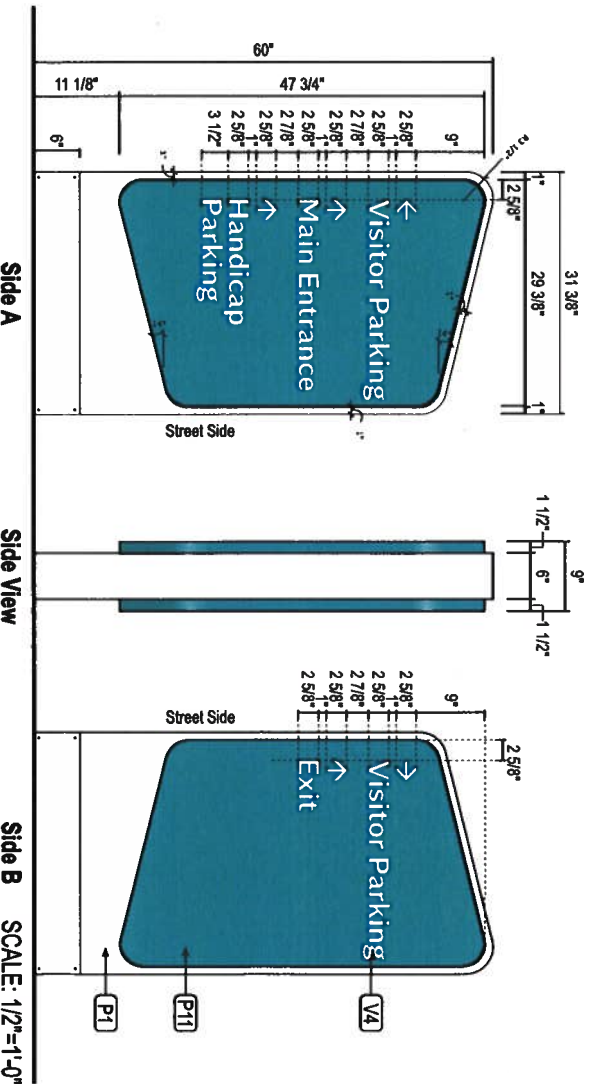
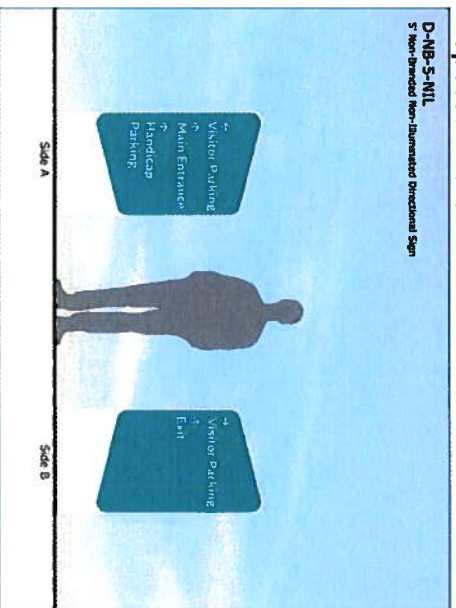

Existing Photo



Existing

Asset Zone:	Sign
Sign Number:	028
Existing Sign Type:	Monument
Face Material:	Vinyl
Graphics Material:	Vinyl
Overall Height:	59'
Face Height:	50'
Face Width:	36.5'
Square Feet:	
Illuminated:	Internally Illuminated
Electrical:	
Wall Material:	
Sign Comment:	10' depth

Recommendation

Description	Sq. Ft.	Qty.
D-BR-5 D.F. Illuminated Directional	18	1

NOTES:
Restore ground material to base of new sign.

Proposed Photo

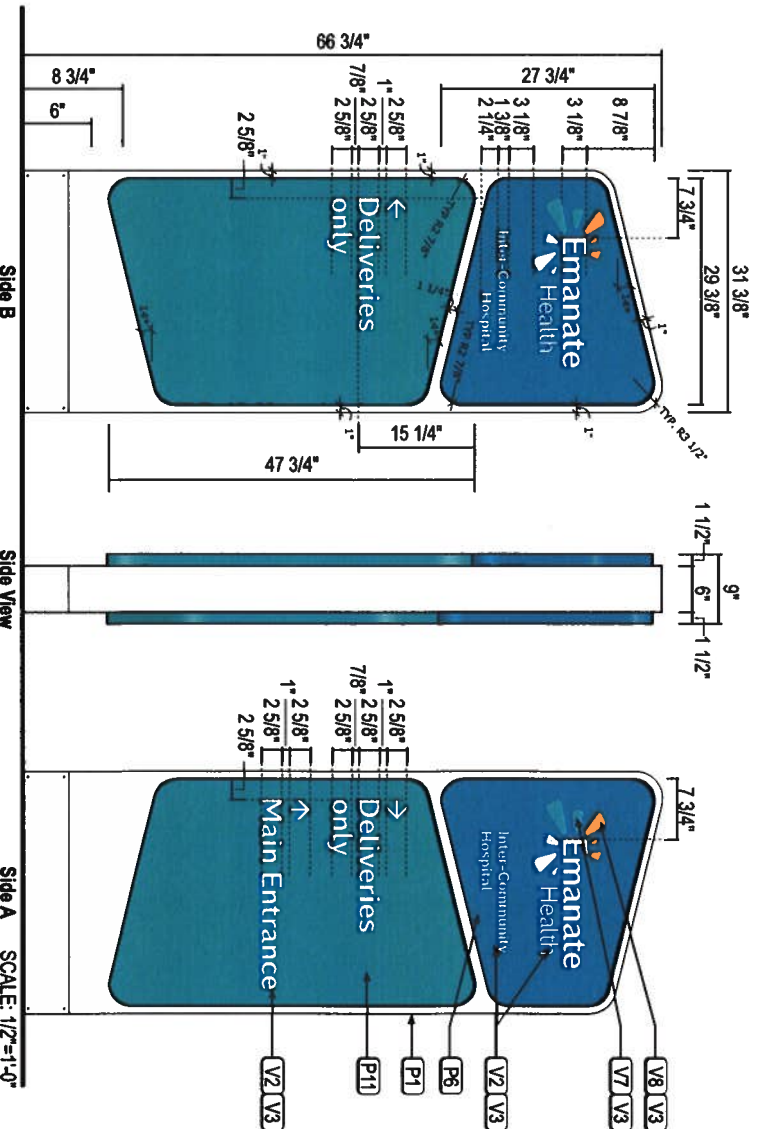
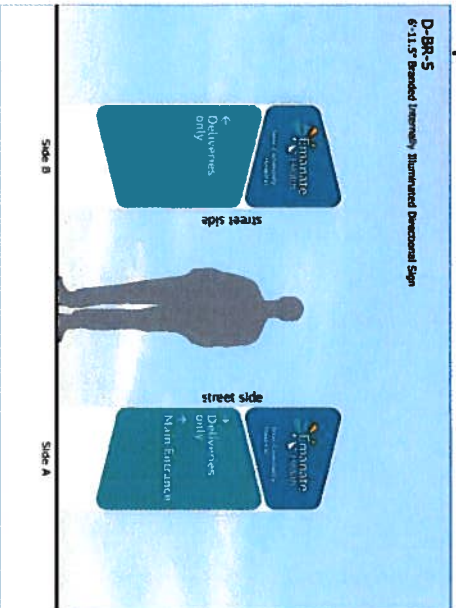

Existing Photo



Existing

Asset Zone:	Sign
Sign Number:	052a
Existing Sign Type:	Monument
Face Material:	Flat Plastic
Graphics Material:	Vinyl
Overall Height:	62'
Face Height:	50'
Face Width:	38'
Square Feet:	
Illuminated:	Internally Illuminated
Electrical:	
Wall Material:	Metal
Sign Comment:	10' depth

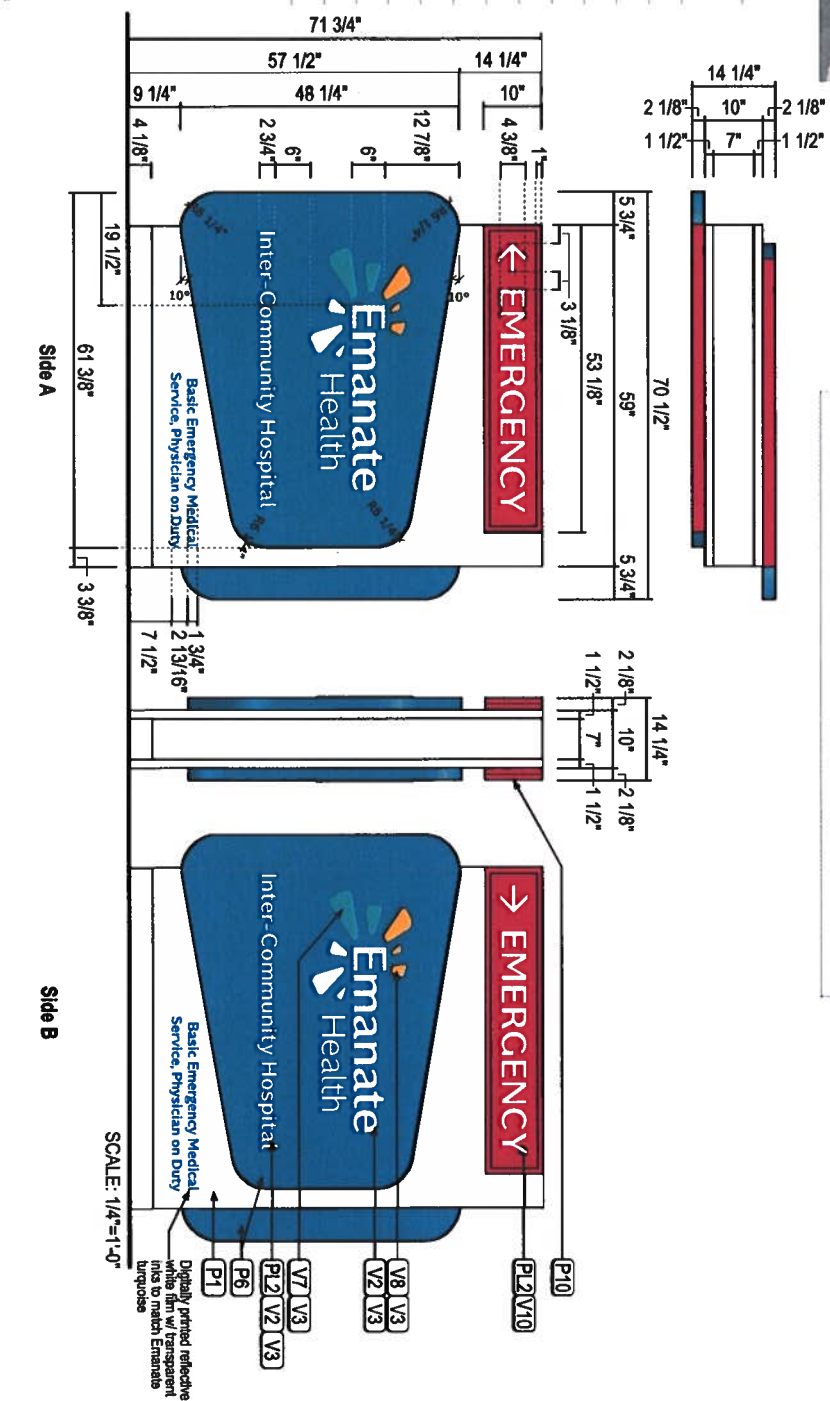



Site Number: CVHP001

CVHP001_Inter-CommunityHospital Print Book

Site Name: Inter-CommunityHospital

Address: 210 W. San Bernardino Road

City/State: Covina, CA 91723

Recommendation Completed: 11-25-2019

Approved: 12-03-2019

Date Print: 01/09/2020

Existing Photo



Proposed Photo



Existing

Asset Zone:	Sign
Sign Number:	070
Existing Sign Type:	Monument
Face Material:	Flat Plastic
Graphics Material:	Routed - Backed Up
Overall Height:	
Face Height:	60"
Face Width:	128"
Square Feet:	
Illuminated:	Internally Illuminated
Electrical:	
Wall Material:	
Sign Comment:	12" cap height on E

Proposed

Sign Number:	070	Overall Height:	
Sign Type:	Custom	Overall Width:	
Description:	Custom Vinyl Logo - Double Sided	Logo Height:	
Action:	Custom Reface	Letter Height:	
Comments:	Add full color logo along with "BASIC EMERGENCY MEDICAL SERVICE PHYSICIAN ON DUTY" at the bottom of the sign as shown. Existing sign is double sided	Illuminated:	Non Illuminated
Restoration Notes:	Remove existing logo. Clear surface of all remaining		

ALREADY INSTALLED

Existing Photo



Proposed Photo



Existing

Asset Zone:	Sign
Sign Number:	080
Existing Sign Type:	Monument
Face Material:	Flat Plastic
Graphics Material:	Routed - Backed Up
Overall Height:	
Face Height:	
Face Width:	110"
Square Feet:	
Illuminated:	Internally Illuminated
Electrical:	
Wall Material:	
Sign Comment:	12" cap height on E

Proposed

Sign Number:	080	Overall Height:	
Sign Type:	Custom	Overall Width:	
Description:	Custom Vinyl logo - Double Sided	Sign Height:	
Action:	Custom Reface	Letter Height:	
Comments:	Add full color logo along with "BASIC EMERGENCY MEDICAL SERVICE PHYSICIAN ON DUTY" at the bottom of the sign as shown in the attached drawing. Recommend to remove landscaping so that the sign is more visible.	Illuminated:	
Restoration Notes:	Remove existing logo. Clean face of sign.		

ALREADY INSTALLED

Existing Photo



Existing

MUST SETBACK FROM PROPERTY LINE

Asset Zone: Sign

Sign Number: 081

Existing Sign Type: Monument

Face Material:

Graphics Material: Vinyl

Overall Height: 80"

Face Height: 3'

Face Width: 4'

Square Feet:

Illuminated: Non Illuminated

Electrical:

Wall Material:

Sign Comment:

Recommendation

Description	Sq. Ft.	Qty.
custom	12.3	1
S.F. Non-Illuminated Post & Panel Lawn Sign		

NOTES:

One alum panel painted to look as shown.
 Vinyl copy applied to painted panels.
 Attached to alum. posts.

Proposed Photo

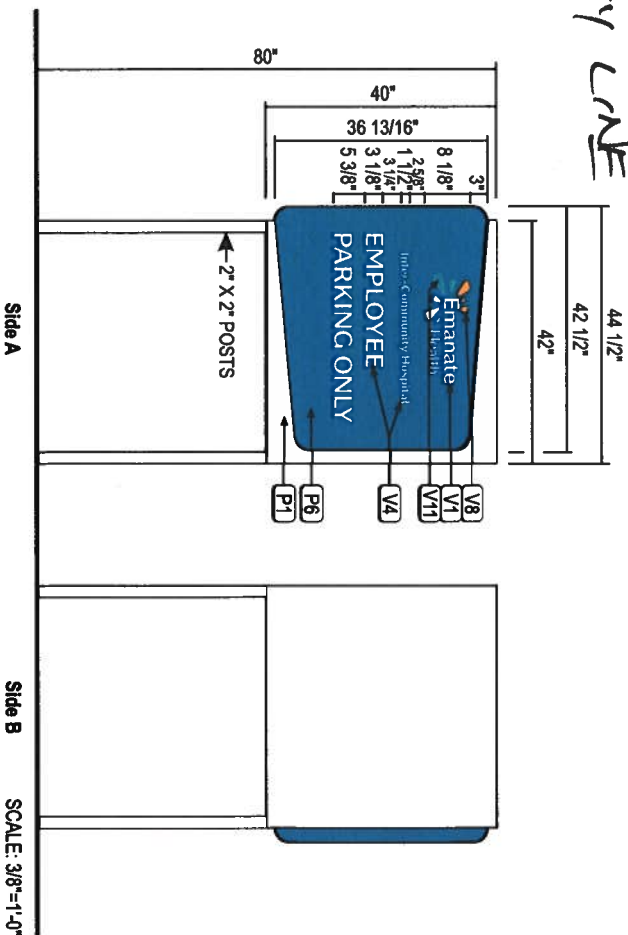
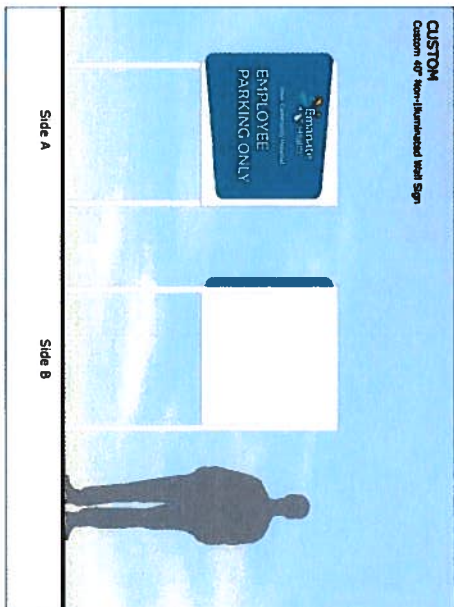

Existing Photo

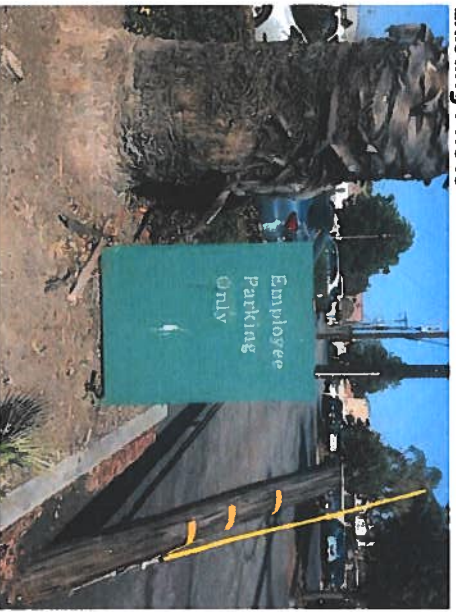

Existing

Asset Zone: Sign

Sign Number: 094

Existing Sign Type: Monument

Face Material: Metal

Graphics Material: Vinyl

Overall Height: 52"

Face Height: 36"

Square Feet: Non Illuminated

Electrical:

Wall Material:

Sign Comment:

Recommendation

Description	Sq. Ft.	Qty.
D-NB-S-NIL S.F. Non-Illuminated Directional	13	1

NOTES:
Restore ground material to base of new sign.

Proposed Photo

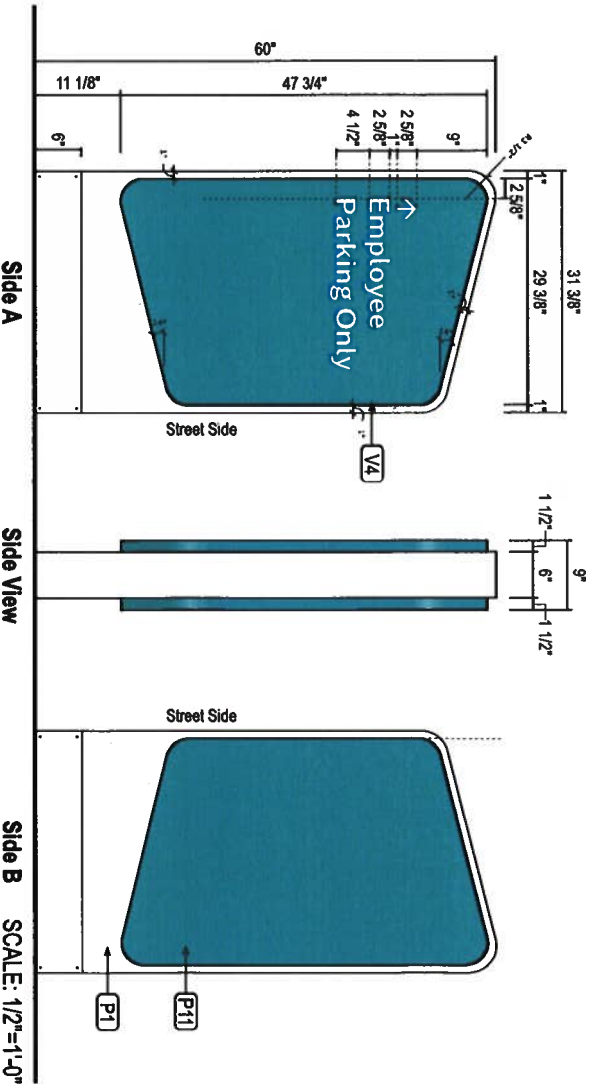
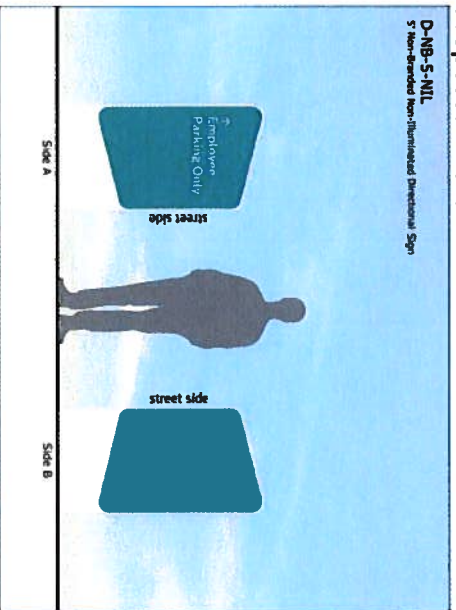

Existing Photo



Existing

Asset Zone:	Sign
Sign Number:	095
Existing Sign Type:	Monument
Face Material:	Metal
Graphics Material:	Vinyl
Overall Height:	52"
Face Height:	36"
Face Width:	36"
Square Feet:	
Illuminated:	Non Illuminated
Electrical:	
Wall Material:	
Sign Comment:	

Recommendation

Description	Sq. Ft.	Qty.
D-NB-5-NIL S.F. Non-Illuminated Directional	13	1

NOTES:
 Restore ground material to base of new sign.

Proposed Photo

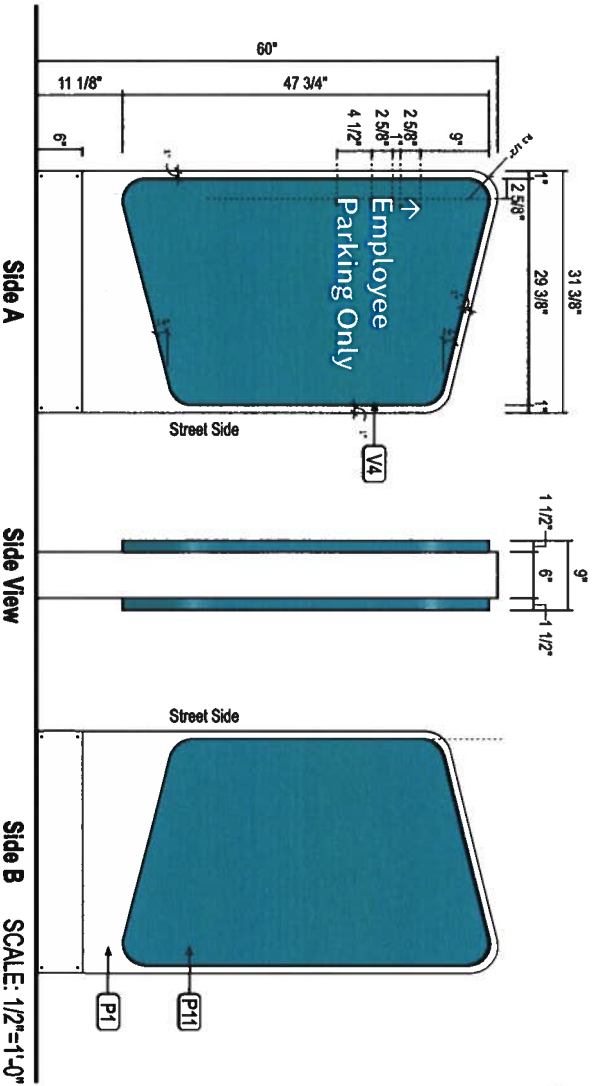
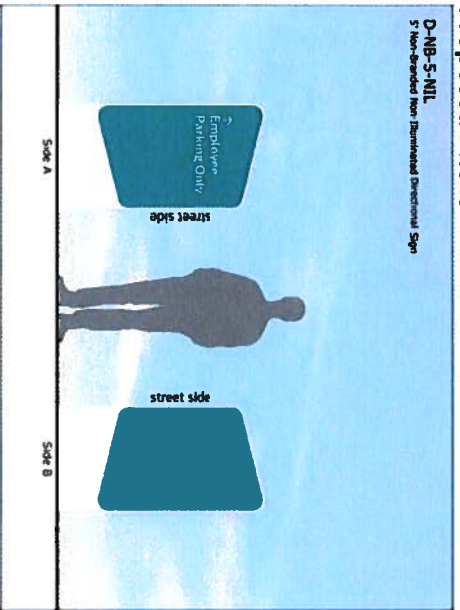

Existing Photo



Existing

Asset Zone:	Sign	
Sign Number:	097	
Existing Sign Type:	Monument	
Face Material:	Vinyl	
Graphics Material:	Vinyl	
Overall Height:	59.5'	
Face Height:	50'	
Face Width:	36'	
Square Feet:	Internally Illuminated	
Illuminated:		
Electrical:		
Wall Material:		
Sign Comment:	10' depth	
Recommendation		
Description		
D-BR-5	Sq. Ft.	Qty.
D.F. Illuminated Directional	18	1
NOTES: Restore ground material to base of new sign.		

Proposed Photo

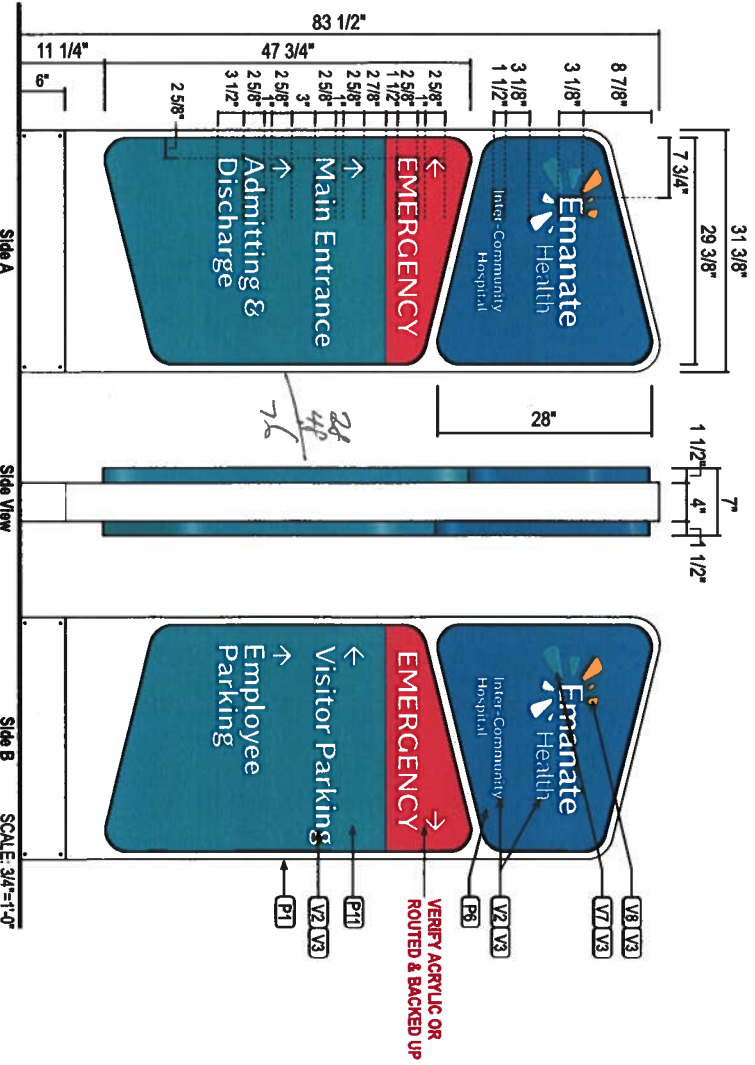
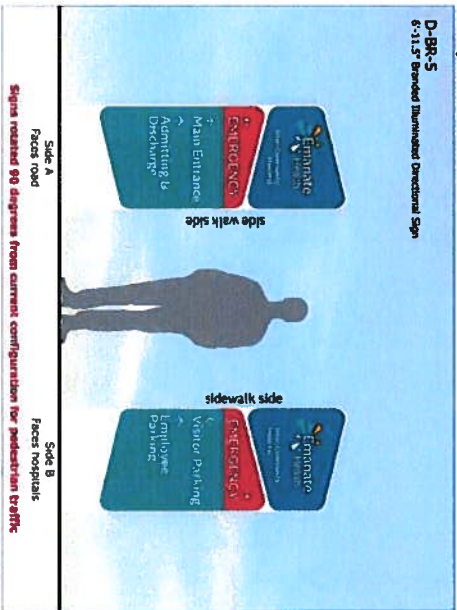

Existing Photo



Existing

Asset Zone:	Sign
Sign Number:	103
Existing Sign Type:	Monument
Face Material:	Flat Plastic
Graphics Material:	Vinyl
Overall Height:	60"
Face Height:	50"
Face Width:	36"
Square Feet:	
Illuminated:	Internally Illuminated
Electrical:	
Wall Material:	
Sign Comment:	10" depth

Recommendation

Description	Sq. Ft.	Qty.
D-NB-5-IL S.F. Illuminated Directional	13	1

NOTES:
 Restore ground material to base of new sign.
 Tech survey to confirm if sign is illuminated.

Proposed Photo

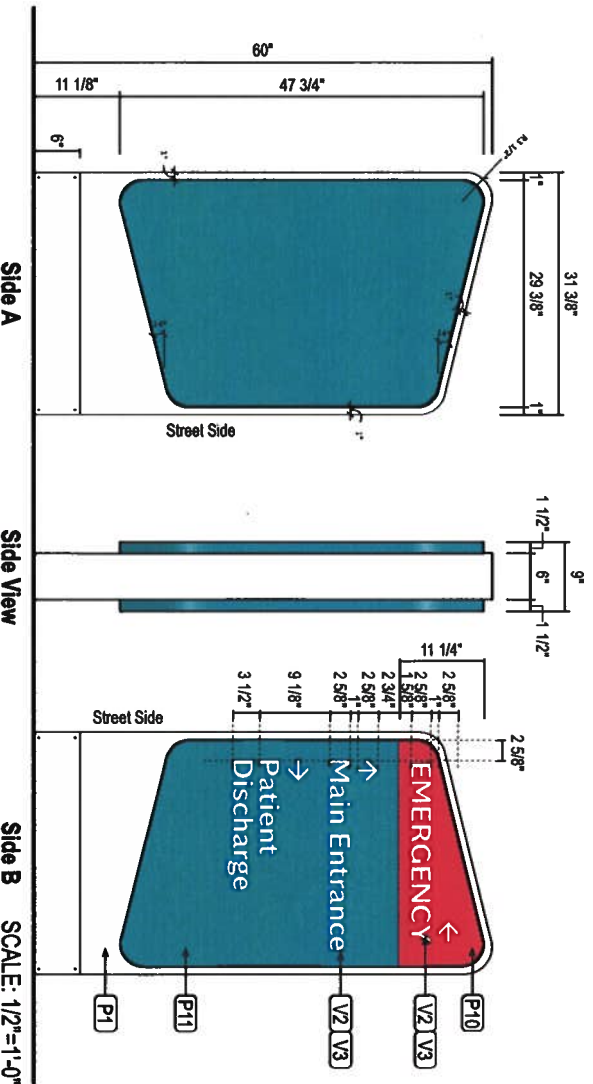
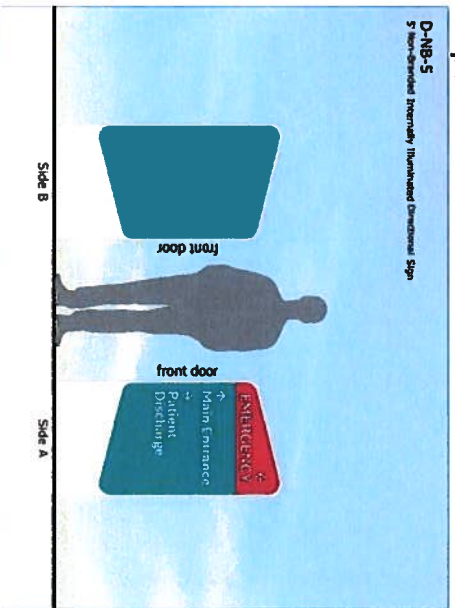

Existing Photo

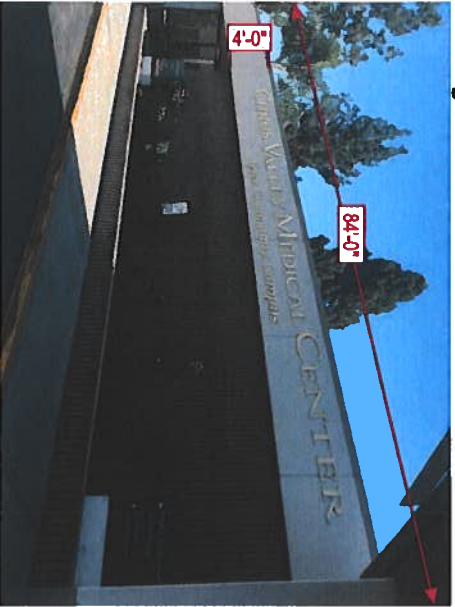

Proposed Photo



Existing

Asset Zone:	Sign
Sign Number:	105, 105A
Existing Sign Type:	Plate Letters
Face Material:	
Graphics Material:	Metal
Overall Height:	
Face Height:	50" face of building
Face Width:	
Square Feet:	
Illuminated:	Non Illuminated
Electrical:	
Wall Material:	
Sign Comment:	

Recommendation

Description	Sq. Ft.	Qty.
DL-16-S-DT / L-12-SL-DT Non-Illum. Dimensional Letters -Deep Teal	111	1

NOTES:
Remove existing letters. Patch/paint existing wall surface to like new condition. Install new letters.

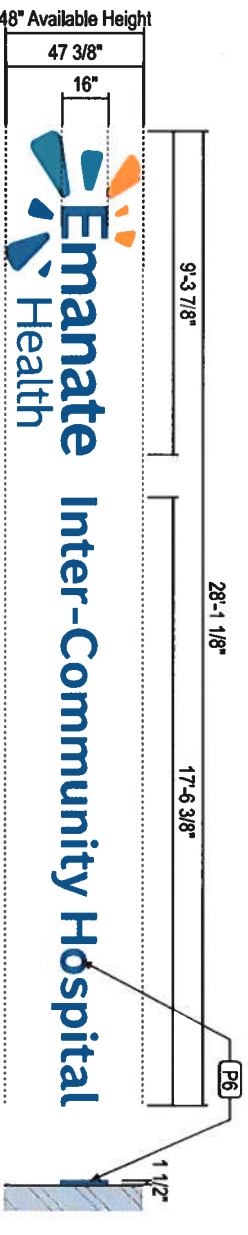

SCALE: 1/4"=1'-0"

Side View

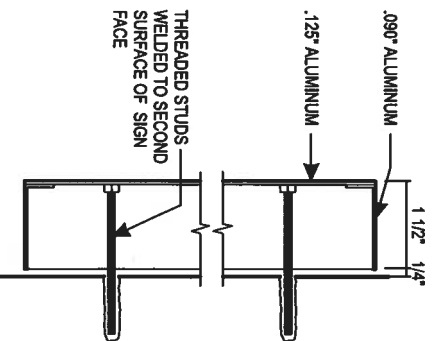

SECTION DETAIL

SCALE: N.T.S.



Site Number: CVHP001

CVHP001_Inter-CommunityHospital Print Book

Site Name: Inter-CommunityHospital

Address: 210 W. San Bernardino Road

City/State: Covina, CA 91723

Recommendation Completed: 11-25-2019

Approved: 12-03-2019

Date Print: 01/09/2020

Existing Photo



Proposed Photo



Existing

Asset Zone:	Sign
Sign Number:	105a
Existing Sign Type:	Plate Letters
Face Material:	
Graphics Material:	Metal
Overall Height:	
Face Height:	50" face of building
Face Width:	
Square Feet:	
Illuminated:	Non Illuminated
Electrical:	
Wall Material:	
Sign Comment:	

Proposed

Sign Number:	105a	Overall Height:	12"
Sign Type:	DL-12-SL-DT	Overall Width:	Varies
Description:	12" Service Line Dimensional Letters - Deep Teal Faces	Logo Height:	n/a
Action:	Remove and Replace	Letter Height:	12"
Comments:	Center on wall	Illuminated:	no
Restoration Notes: Patch and repair existing wall surface to like new condition. Repaint to match existing color finish. For brick or stone walls fill holes with matching silicone. Power wash wall if required. See master agreement for removal requirements. Field verify dimensions of space shown in photo morph prior to fabrication to verify if specified letterset will fit in area and meet clear zone tolerances - refer to Control Documents. ***Change letterset height if required. See control documents for product specification and master agreement for installation requirements.			

Existing Photo



Existing

Asset Zone:	Sign
Sign Number:	106
Existing Sign Type:	Monument
Face Material:	Flat Plastic
Graphics Material:	Vinyl
Overall Height:	59"
Face Height:	50"
Face Width:	36"
Square Feet:	
Illuminated:	Internally Illuminated
Electrical:	
Wall Material:	
Sign Comment:	10" depth

Recommendation

Description	Sq. Ft.	Qty.
D-AB-5-IL S.F. Illuminated Directional	13	1

NOTES:
Restore ground material to base of new sign.
Tech survey to confirm if sign is illuminated.

Proposed Photo

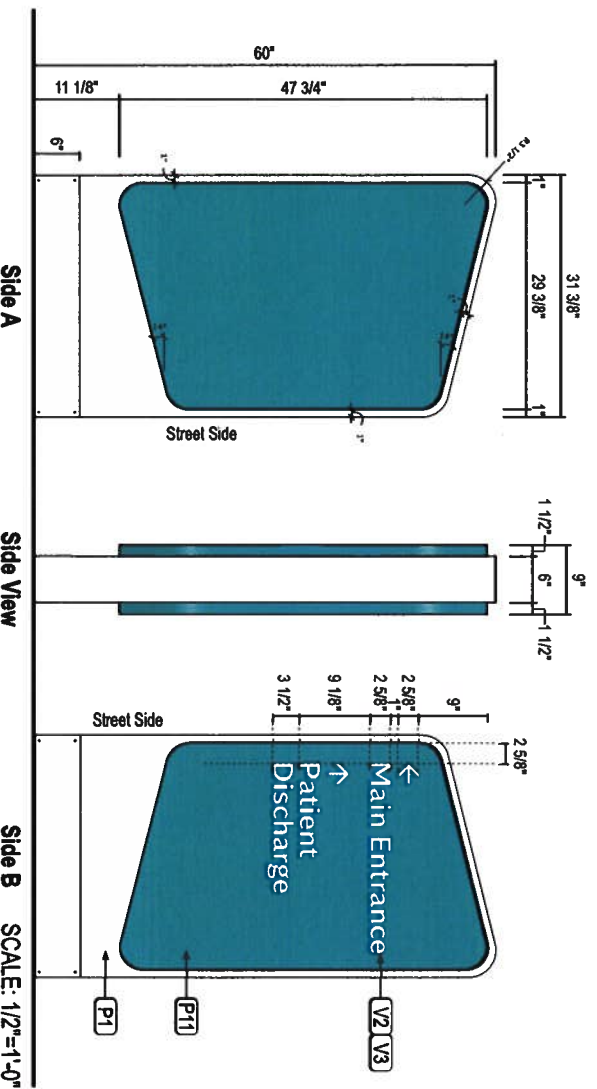
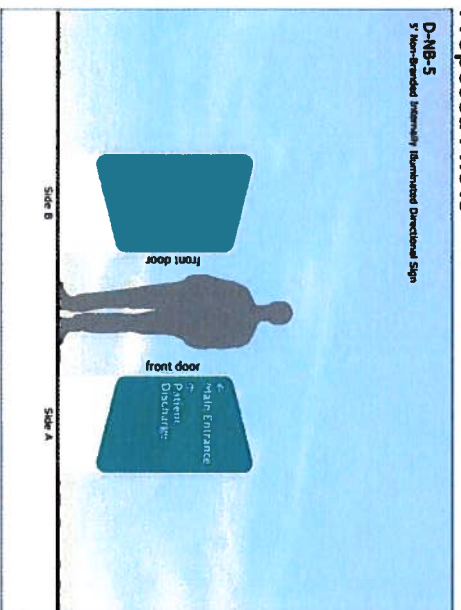

Site Number: CV/HP001

CV/HP001_Inter-CommunityHospital Print Book

Site Name: Inter-CommunityHospital

Address: 210 W. San Bernardino Road

City/State: Covina, CA 91723

Recommendation Completed: 11-25-2019

Approved: 12-03-2019

Date Print: 01/09/2020

Existing Photo



Proposed Photo

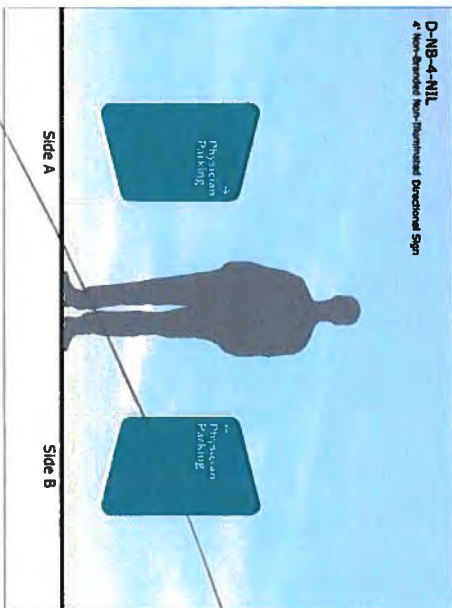

Existing

Asset Zone: Sign

Sign Number: 150

Existing Sign Type: Monument

Face Material: Flat Plastic

Graphics Material: Vinyl

Overall Height: 61'

Face Height: 21.5'

Face Width: 48'

Square Feet:

Illuminated: Non Illuminated

Electrical:

Wall Material:

Sign Comment:

Proposed

Sign Number: 150

Sign Type: Remove

Description: Remove Existing Sign

Action: Remove

Comments: Sign 152 is close to this sign and conveys the same information. Only one sign is needed.

Restoration Notes: Remove support pole to grade and cap. Restore ground material and clean area of all debris. See master agreement for removal requirements.

Overall Height:

Overall Width:

Logo Height:

Letter Height:

Illuminated:

Removed

Existing Photo



Existing

Asset Zone:	Sign
Sign Number:	184
Existing Sign Type:	Monument
Face Material:	Metal
Graphics Material:	Vinyl
Overall Height:	
Face Height:	48"
Face Width:	36"
Square Feet:	
Illuminated:	Non Illuminated
Electrical:	
Wall Material:	
Sign Comment:	

Recommendation

Description	Sq. Ft.	Qty.
D-NB-5-NIL S.F. Non-Illuminated Directional		1

NOTES:
 Restore ground material to base of new sign.

Proposed Photo

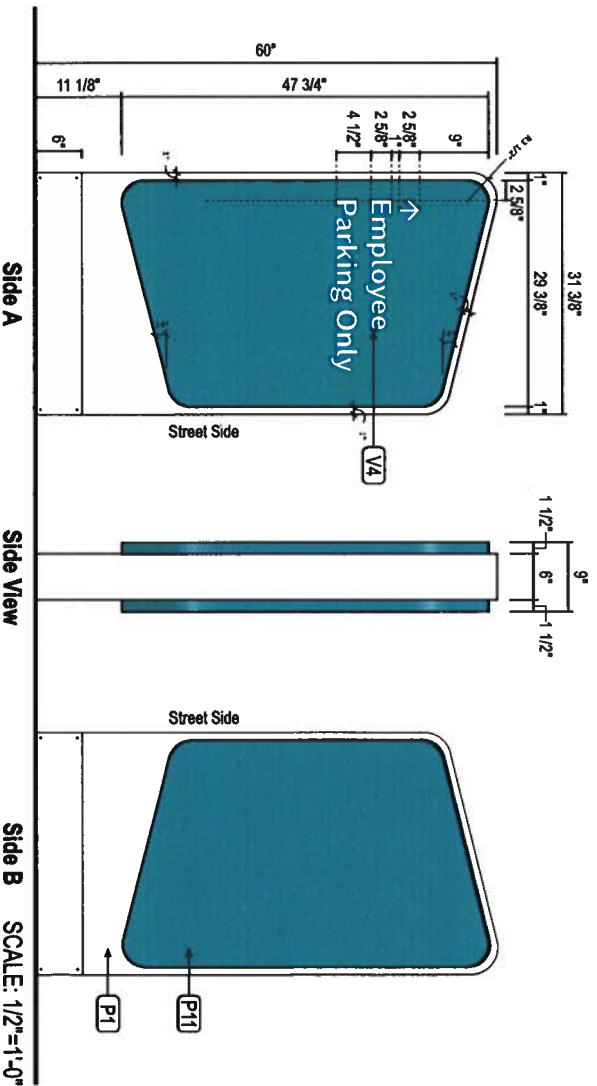
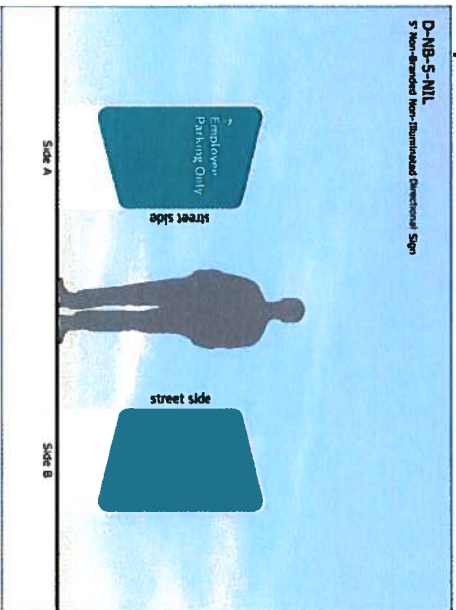

Existing Photo



Proposed Photo

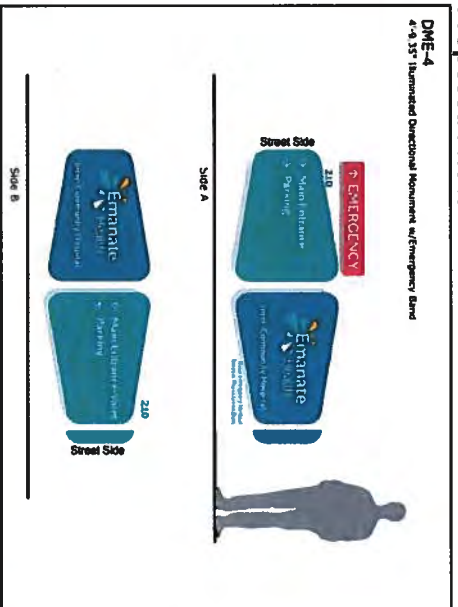

Existing

Asset Zone:	Sign	
Sign Number:	192	
Existing Sign Type:	Monument	
Face Material:	Flat Plastic	
Graphics Material:	Vinyl	
Overall Height:	70.5"	
Face Height:	50.5"	
Face Width:	50.5"	
Square Feet:	Illuminated	
Electrical:		
Wall Material:		
Sign Comment:		
Recommendation		
Description	Sq. Ft.	Qty.
DME-4 D.F. Illuminated Directional Monument	42.7	1

